

ULTRADESK®

FRAG

V3

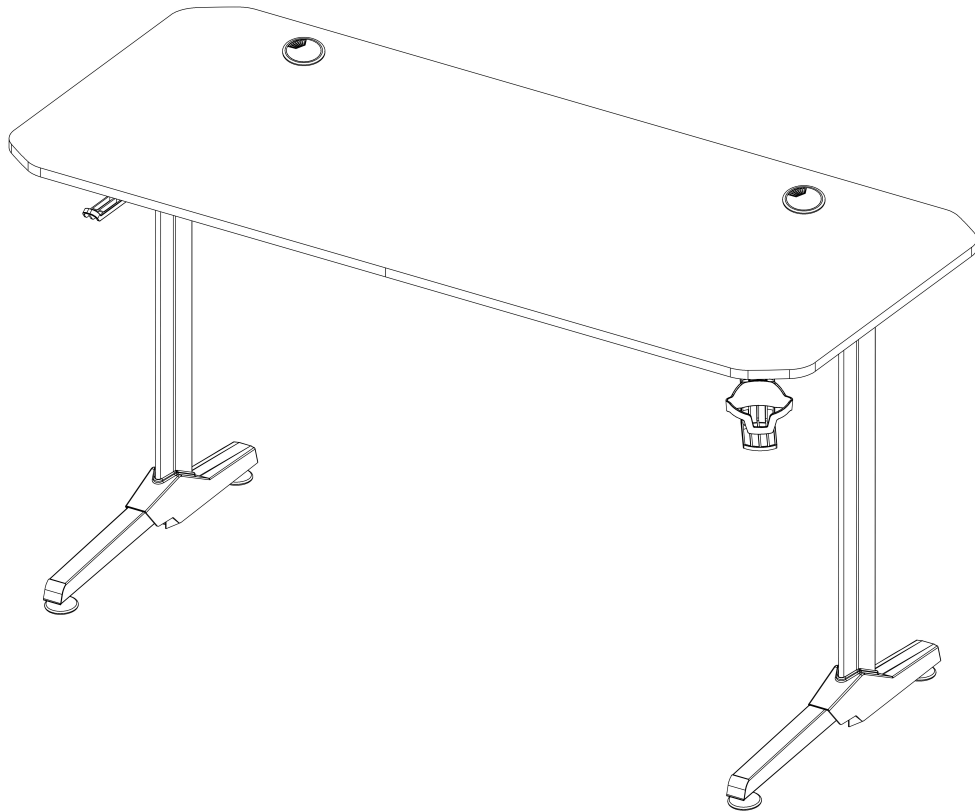

M10*20
N*6



M*4



M8*16
O*10



M4*14
P*34

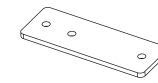

Q*1



R*2



6mm
U*1

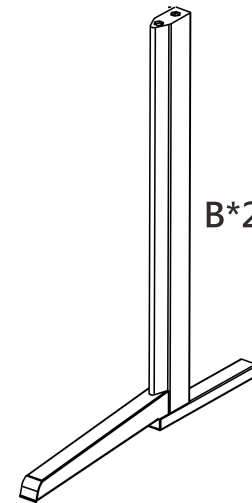

B*2

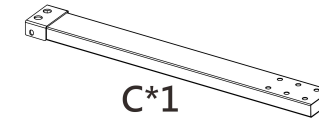

C*1

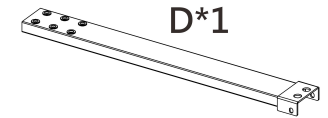

D*1

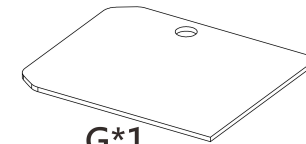

G*1

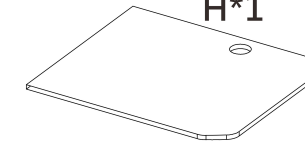

H*1

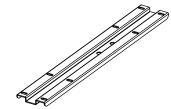

E*1



T*2

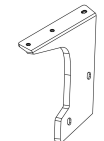

K1

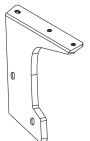

K2

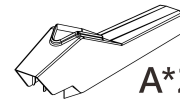

A*2

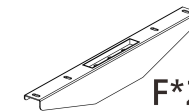

F*2

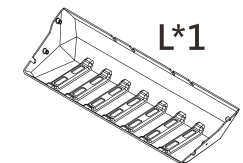

L*1



I*1



J*1

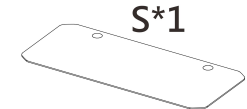

S*1

